



6390 Phillips Highway  
 Jacksonville, FL 32216  
 Phone (904) 737-7144

**SPECIFICATION DATA SHEET**

**MODEL No. 350 - D**

**ROOF CAP  
 with BACK DRAFT DAMPER**

Date: 12/08/06 rev. Drawn by: M.D.C.

**DIMENSIONAL DATA**

SIZE	3"	4"	5"	6"	7"	10"
"A"	6"	6"	8"	8"	8"	11"
"B"	6"	6"	8"	8"	8"	11"
"C"	3-1/2"	3-1/2"	5"	5"	5"	5"
"D"	12"	12"	14"	14"	14"	17"
"E"	12"	12"	14"	14"	14"	17"
"F"	4-1/2"	4-1/2"	5"	5"	5"	7"
"G"	2-1/2"	2-1/2"	4"	4"	4"	4"

**FABRICATION DATA**

MATERIAL: 28 GAUGE GALVANIZED STEEL SHEET.

**FEATURES**

- HINGED LIGHT GAUGE GALVANIZED STEEL BACK DRAFT DAMPER.
- ROUND COLLAR INSTALLED IN BOTTOM PLATE.
- ROUND COLLAR IN BOTTOM PLATE SEALED WITH SILICONE SEALANT.
- SLOT OPENING FOR WATER DRAINAGE.

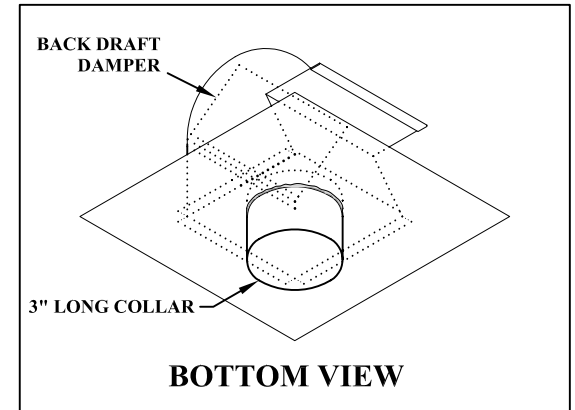
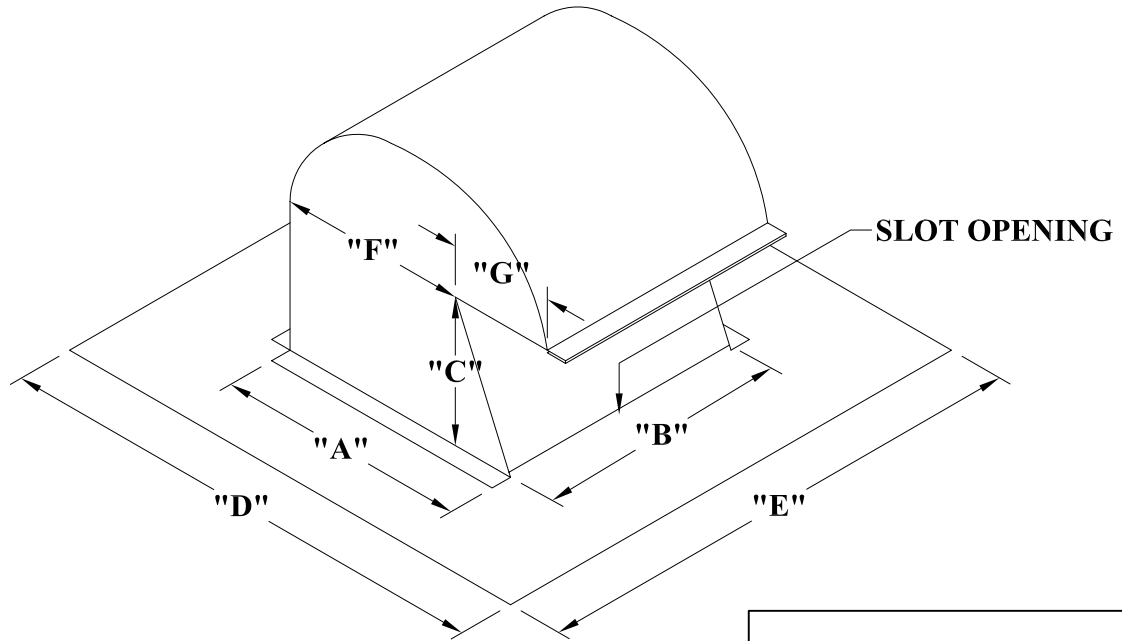

**OPTIONS**

**SPECIAL NOTES**

WE DO NOT WARRANT THESE ROOF MOUNTED FITTINGS TO BE LEAK-PROOF AGAINST ALL WEATHER CONDITIONS.  
 WE DO NOT GUARANTEE THE FITTINGS WILL PREVENT RAIN WATER INTRUSION FROM WIND BLOWN RAIN OR TORRENTIAL STORM CONDITIONS.  
 ADDITIONAL SEALING MIGHT BE NECESSARY AT THE DISCRETION OF THE INSTALLER.